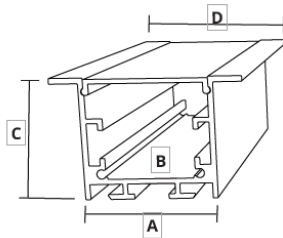

PHYSICAL

Material	Anodized Aluminum
Lens Cover	Polycarbonate
Width	A:1.39"(35.25mm)
Inner Width	B: 0.96"(24.50mm)
Height	C:1.39"(35.25mm)
Flange Width	D:2.00"(30.24mm)
Length	39" or 78"

DIMENSIONS

FINISH

Satin Aluminum

ACCESSORIES

	PART#
Plastic End Cap	AMC-3535-R-EC
Plastic End Cap w/hole	AMC-3535-R-ECL
Spring Clip	AMC-3535-R-SC
Opal Lens	AMC-3535-R-O

ACCESSORIES

	PART#
Bracket Straight	AMC-3535-R-BS
Bracket 90 Vertical	AMC-3535-R-B90V
Bracket 90 Horizontal	AMC-3535-R-B90H

SPECIFICATION

SERIES	DIMENSIONS	CHANNEL TYPE	LENGTH	LENS TYPE	FINISH
AMC = Channel	3535= H 35.00mm x 35.00mm	R=Recessed Mount Channel	1M = 39" 2M = 78" XX* = Custom	O = Opal Lens	SL = Satin Aluminum



ACCESSORIES
AMC-3535-R-EC

Plastic End Cap

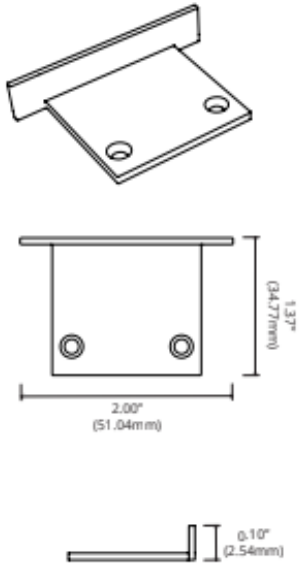
AMC-3535-R-ECL

Plastic End Cap w/Hole

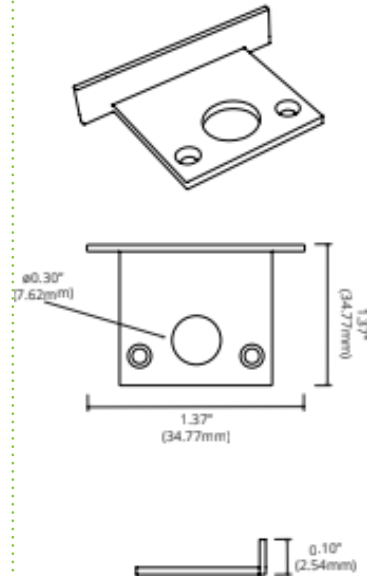
AMC-3535-R-C-SC

Spring Clip

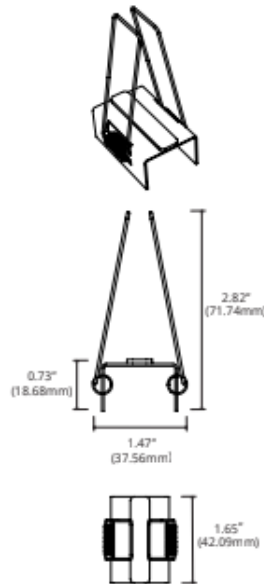
AMC-3535-R-O

Opal Lens

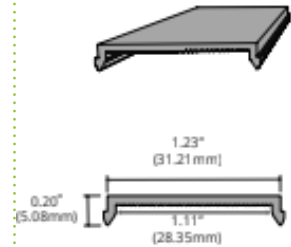
AMC-3535-R-BS

Bracket Straight

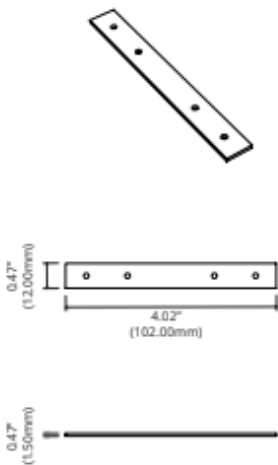
AMC-3535-B90V

Bracket 90 Vertical

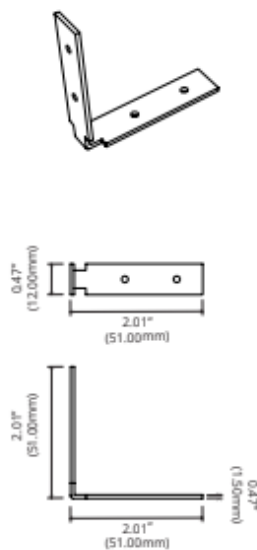
AMC-3535-B90H

Bracket 90 Horizontal

